

EN

**WIRED FRONT PARKING SENSOR KIT 514F****1.0 - HOW THE SYSTEM WORKS**

- Installation and configuration tasks should only be performed by qualified personnel.
- Front parking sensors will ensure that a safe distance is maintained to other vehicles.
- The parking system is designed as an assist device only, it should not be considered to replace attentiveness while maneuvering at low speeds in and out of confined spaces nor substitute safe driving practices.

The PDC system comes with 1 acoustic warning loudspeaker (master device), 1 resin-filled control unit (slave device), a manual ON/OFF switch with LED indicator and 4 compact waterproof paintable sensors. The proximity sensors are configurable via the loudspeaker (buzzer) according to your preferences and bumper type (contact a Gemini authorized Service Center).

**1.1 - ACTIVATION:** The system activates automatically when ignition is turned ON and carries out a complete operating self-diagnostic test. If all sensors are operative, the LED on the ON/OFF switch turns ON and 1 Beep will confirm activation. If, on the other hand, one of the sensors is faulty, a deep error tone (Bop) will sound followed by the number of Beeps corresponding to the faulty sensor. From this moment on, communication between the 2 devices remains active until ignition is switched OFF to monitor the area in front of the vehicle.

**1.2 - DEACTIVATION:** This operation is managed by the loudspeaker based on the system configuration:

1. **Manual deactivation via ON/OFF dash switch** (to avoid warning beeps in traffic jams, at traffic lights, queues etc.):
  - Short press (approx. 0,5 sec.) => sensors remain OFF until the button is pressed again or, if the buzzer is connected to the odometer, they will switch ON automatically when the vehicle speed goes back under the set speed.
  - Long press (approx. 3 sec., until you hear a Bop) => sensors remain disabled until ignition is turned OFF and ON again. Sensors can be re-enabled via the ON/OFF switch.
2. **Maneuvering time period expired:** When the "Deactivation delay" feature is configured, the sensors, if no obstacle is detected, will turn OFF after 30 or 60 sec. according to the selected configuration. If, during this period, an obstacle is detected, the switch OFF delay time will extend to 120 sec. (max.). If configured with code "51" (see Configuration table, par. 12.0), sensors are only switched OFF manually via the dash switch.
3. **Speed signal (Odometer):** Sensors switch OFF when the vehicle speed exceeds the set speed and they automatically switch ON when the vehicle speed falls below the set speed. Only the LED on the dash switch will light up to confirm reactivation.

**1.3 - OBSTACLE DETECTION**

Detection of obstacles is signalled by the buzzer with an audible proximity warning when driving forward: the faster the beeping the closer the obstacle. The warning tone becomes continuous when the distance between the obstacle and the vehicle reaches the set STOP threshold.

**1.4 - SENSOR DETECTION INFORMATION**

Certain conditions may affect the ability of the sensor to correctly detect obstacles:

1. Presence of human beings, animals or small obstacles or objects/materials with low reflectance might not be detected by the parking system.
2. In case of heavy rain/snow the parking system might give an audible alert even if no obstacles are present: this does not necessarily indicate that the PDC is defective.
3. If the sensors are covered with mud, ice or snow (normal function resumes after cleaning or defrosting).
4. An extremely bumpy road or an incline, gravel or grass.
5. Vehicle horns, motorcycle engines, air brakes of large vehicles or other loud noises producing ultrasonic waves.
6. Heavy rain or splashes on the sensors and water puddles.
7. Obstacles located below the bumper will not be detected when they are in close proximity.

**1.5 - SENSOR FAILURE INDICATION**

When ignition is turned ON, the system provides an instant, automatic, self-diagnostic function. If all the sensors are operative the LED on the ON/OFF switch will light up and 1 Beep will confirm activation. If one of the sensors is faulty or disconnected, a deep error tone (Bop) will sound followed by the number of beeps corresponding to the faulty sensor. The cycle will repeat until all faulty sensors have been signaled. 2 Bops will confirm the end of the self-test cycle. The system will exclude any faulty sensor and keep the other ones active. The following is an example of error indications:

**Sensor 1 inoperative** => 1 Bop + "1 Beep" + 2 closing Bops.

**Sensor 1 and 2 inoperative** => 1 Bop + "1 Beep" + 1 Bop + "2 Beeps" + 2 closing Bops.

**1.6 - BASIC MAINTENANCE TIPS**







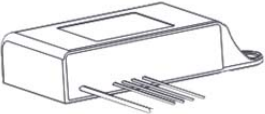

- When cleaning the sensors take special care not to scratch or damage the surface: carefully clean the sensors with a soft cloth.
- In car washes which use steam jet or high-pressure washers, keep the nozzle at least 10 cm away from the sensors.

**2.0 - WARRANTY CONDITIONS**

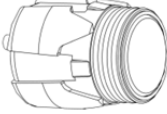
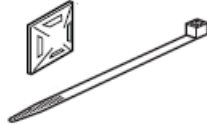
This product is guaranteed to be free from manufacturing defects for a period of 24 months from the installation date shown on the warranty certificate, in compliance with Directive 1999/44/CE L.D. N.24 dated 02/02/2002. Please fill-in entirely the warranty certificate that accompanies the product and DO NOT REMOVE the bar code warranty label from the device. The warranty will become void if labels are missing or torn, if the warranty certificate is not fully compiled or if the enclosed sales document is missing.

The warranty is valid exclusively at authorized Gemini Technologies Service Centers. The manufacturer declines any responsibility for eventual malfunctions of the device or any damage to the vehicle electrical system due to improper installation, use or tampering.

### 3.0 - KIT CONTENTS

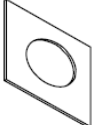
<p><b>A</b></p>  <p>1x resin filled control unit complete with wiring</p>	<p><b>B</b></p>  <p>1x acoustic warning buzzer for programming complete with wiring</p>	<p><b>C</b></p>  <p>4x sensors</p>	<p><b>D</b></p>  <p>4x cable clips 10x zip-ties</p>	<p><b>E</b></p>  <p>1x ON/OFF switch with LED + connector</p>
<p><b>F</b></p>  <p>4x 10° angled external adapters</p>	<p><b>G</b></p>  <p>4x standard external adapters</p>	<p><b>H</b></p>  <p>4x 10° angled inner adapters</p>	<p><b>I</b></p>  <p>4x standard inner adapters</p>	<p><b>J</b></p>  <p>8x adhesive pads</p>

### 4.0 - TOOLS

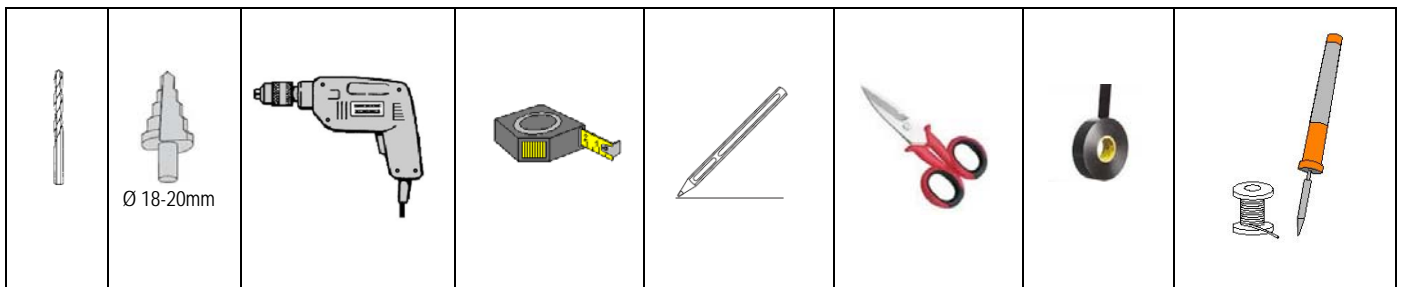

### 5.0 - SPRAY PAINT - SENSOR HEADS AND ADAPTERS

Sensors and adapters can be spray painted before assembly to match the color of the vehicle (optional). To spray paint proceed as follows:

1. Use isopropyl alcohol to clean the sensors and the adapters and let dry. Avoid touching the cleaned surfaces.
2. Insert the selected adapters in the supplied cardboard template:
  - **Center adapters** => fully insert into the cardboard template slots from the top side.
  - **Outer adapters** => press halfway down the slots, up to the side tabs, from the top side.
3. The sensors must be inserted in the central slots from underneath the cardboard. For a perfect spray-paint finish, we recommend turning down the black silicone seal around the sensor head before inserting the sensor into the slots (paint might not adhere to the silicone).

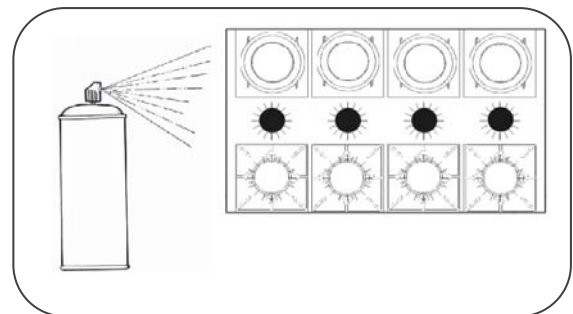
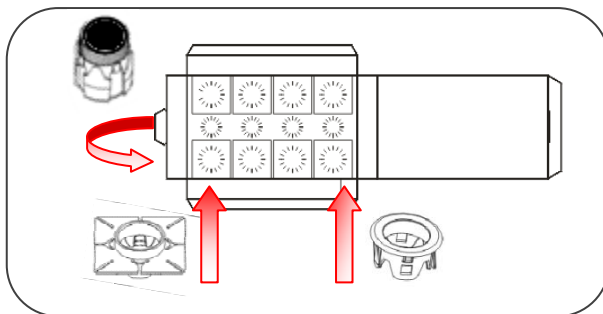

4. Fold the cardboard template into a box. Spray paint the sensors and the adapters and let dry thoroughly before assembling.  
**NB:** Too much spray paint can impair the sensors performance.

## 6.0 - INSTALLATION PRECAUTIONS



- Installation and connections should only be done by qualified personnel.
- Disconnect the negative battery terminal before connecting any wire.
- Some bumpers have factory markings on the inner side; before drilling any holes, make sure they correspond to the recommended positions.
- Some bumpers require correction adapters around the sensors to obtain the proper fitting angle.

## 7.0 - PREPARING FOR INSTALLATION

System performance will depend on the correct positioning and angling of the sensors.

1. Accurately calculate and mark the sensor positions on the bumper.
2. Remove the bumper and make sure there are no obstructions that may hinder the fitting of the sensor heads and the control unit. (ECU)
3. Use a small diameter bit to drill pilot holes for each sensor.
4. Finish the holes to the proper diameter using a cone drill bit that matches the diameter of the selected adapters.

## 8.0 - INDICATIVE SENSOR SPACING AND HEIGHT

Determine the correct mounting height and position to achieve the best detecting angle and distance (the figures shown below are purely indicative).

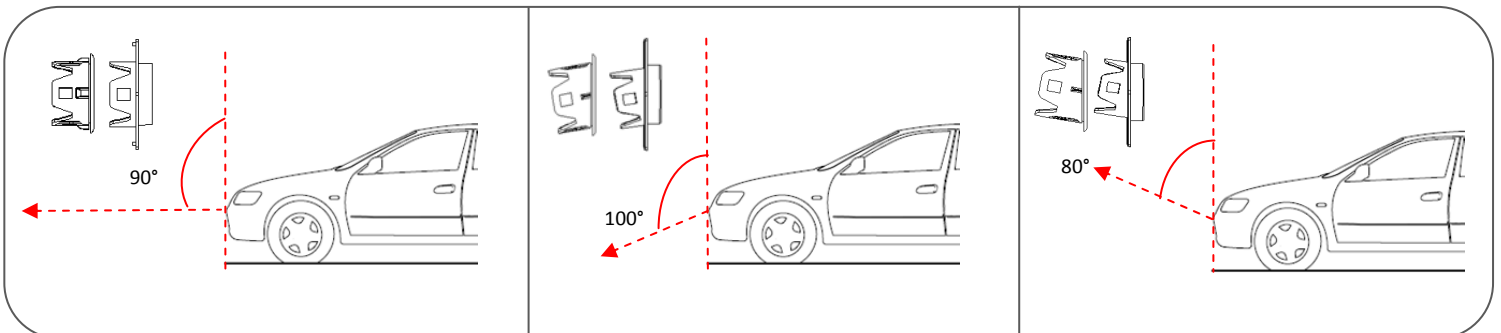
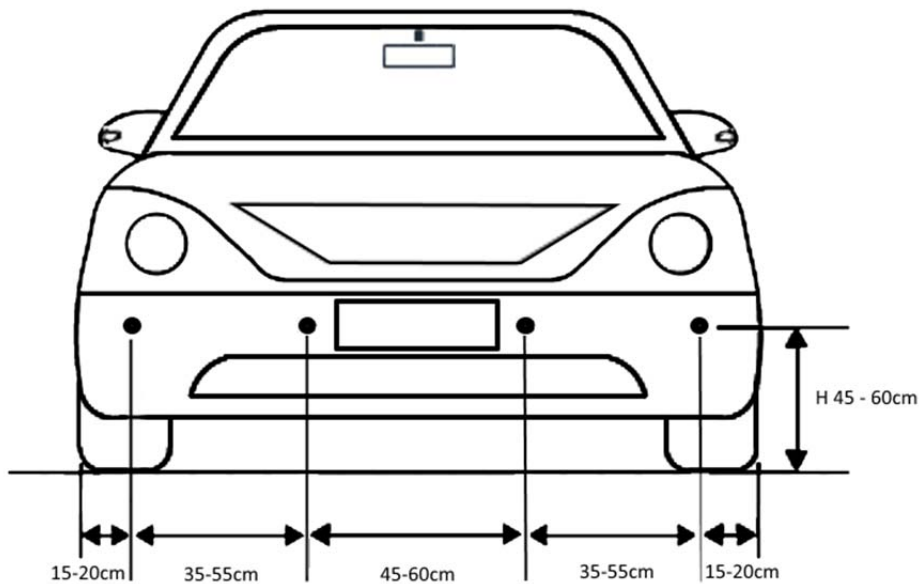

## 9.0 - INSTALLATION

### 9.1 - CONTROL UNIT AND LOUDSPEAKER (BUZZER)

1. Find a suitable location behind the front bumper and fit the control unit using the supplied double-sided tape or zip-ties.
2. Use the supplied double-sided tape or screws to mount the buzzer somewhere inside the cabin where the driver will clearly hear the warning signals.

### 9.2 - ON/OFF MANUAL SWITCH WITH LED INDICATOR

Mount the ON/OFF switch in a suitable "easy-to-reach" location on the dash. If drilling a hole, make sure that there is no obstruction behind the dash in that location.

### 9.3 - SENSORS

The parking sensors can be fitted either from the inside of the bumper (Fig. A) or from the outside (Fig. B) with the specific snap-in adapters.

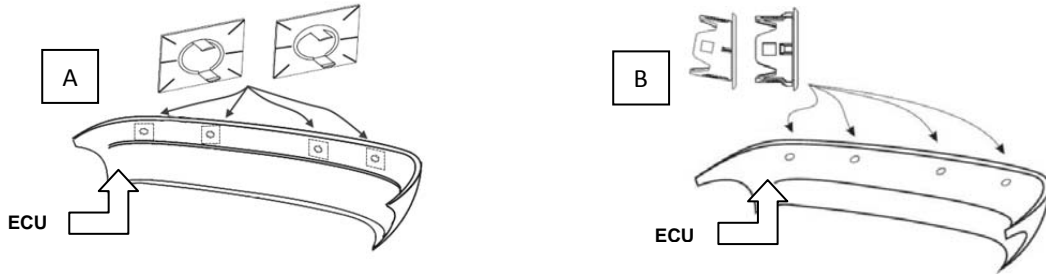

### 9.4 - INSTALLATION ON THE INSIDE OF THE BUMPER:

1. Clean and degrease around the fitting holes.
2. Choose the suitable type of adapters according to the bumper shape:
  - Standard ( $\varnothing$  18mm hole)
  - Angled  $10^\circ$  ( $\varnothing$  20mm hole) to correct the angle of the sensor heads on bumpers that curve up or down.
3. Peel off the adhesive film on one side of the pad and apply on the front side of the adapter as shown below (Fig.1).
4. Peel off the remaining adhesive liner and align the adapters on the 4 holes previously drilled in the bumper (Fig.1).
5. Clip the sensors into the adapters with the arrows and the UP indication facing upwards (Fig.2).

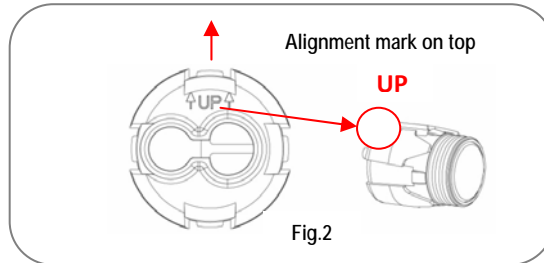
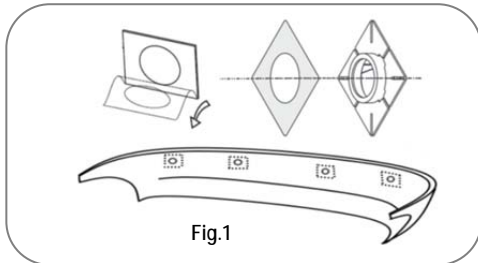

6. Connect the sensors to the wires coming from the control unit as indicated below. The present instructions apply to left-hand drive vehicles, for right-hand drive vehicles, fitting steps must be switched around.

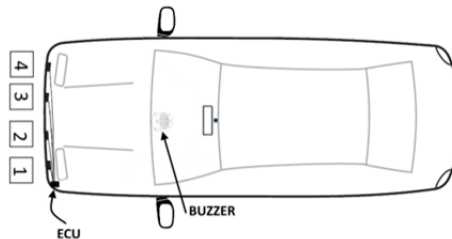

7. Space out the supplied adhesive cable clips along the bumper, insert the cable ties and secure the wires in place. Bundle up any excess cables.
8. Put the bumper back in place without bolting it up.

### 9.5 - INSTALLATION ON THE OUTSIDE OF THE BUMPER:

1. Choose the suitable type of adapters according to the bumper shape and drill four  $\varnothing$  20mm holes.
2. Press down the standard or angled adapters in place on the outer side of the bumper and proceed as indicated above for the inner installation, from step 5.

## 10.0 - ELECTRICAL CONNECTIONS

The PDC kit is directly Plug & Play connected as follows:

1. Connect the 4 wires coming out of the control unit to the 4 sensors (the longest wires to the sensors at the opposite end of the control unit).
2. Connect the 2 connectors coming out of the control unit to the buzzer corresponding connectors (RED-RED and BLACK-BLACK).
3. After the ON/OFF switch is fitted on the dash, connect the 3 wires to connector "1". Make sure the color of the wires attached to each pin matches the color of the wires on the corresponding connector "2" as shown below.
4. Connect switch connector "1" to loudspeaker connector "2".

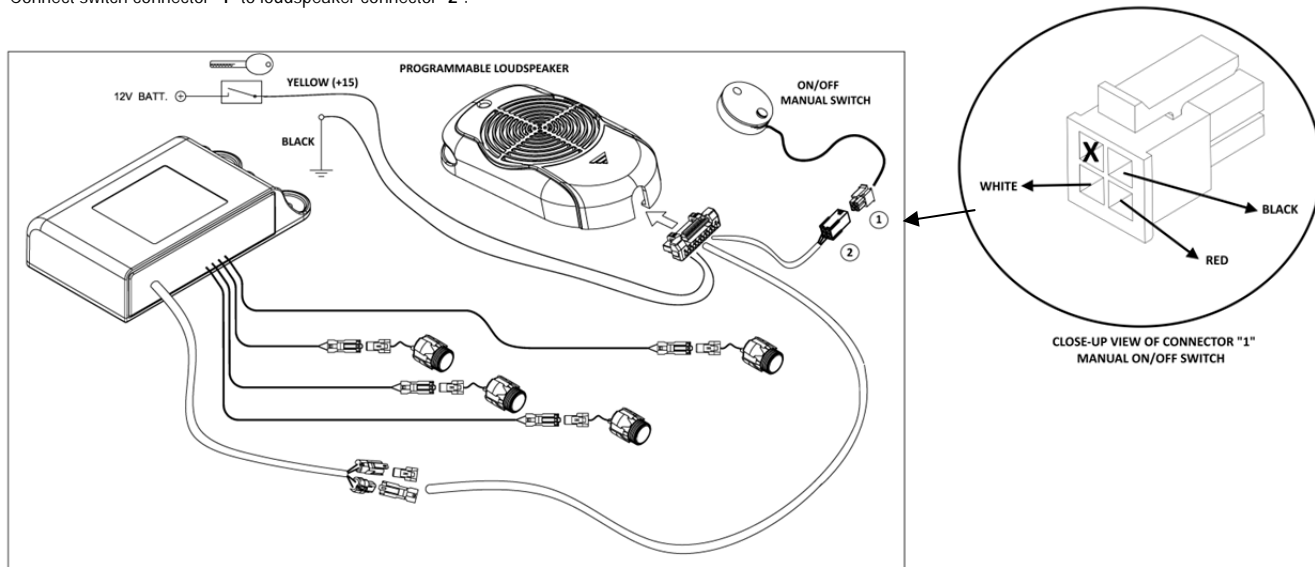

### 10.1 - OPTIONAL CONNECTIONS:

1. **BLUE/BLACK wire:** by connecting this wire to the reverse backup light, the sensors will automatically switch ON when reverse gear is selected during a parking maneuver (when slotting back and forth into a parking space).
2. **VIOLET wire:** by connecting this wire to the odometer you can set a speed threshold so that the system automatically shuts OFF when the vehicle exceeds the set speed and automatically turns ON when the speed falls below the set speed (configuration "58").  
The system can also be set to turn ON when ignition is switched ON and turn OFF when the vehicle reaches the set speed (configuration "59"). In this case the system can only be reactivated via the manual switch.
3. **BROWN wire:** by connecting this wire to the radio MUTE, volume is temporarily excluded or reduced when an obstacle is detected.

### 10.2 - ODOMETER PULSE READING:

Turn ignition key ON. To set a speed threshold, when pulses/meter are known, use the values indicated in the configuration table (par. 12.0) otherwise program parameter "98" to allow the buzzer to record the pulses. An acoustic signal will confirm the buzzer is in speed reading mode. The ON/OFF switch LED will also light up. Without turning ignition key OFF, start the engine and drive a short distance. At the desired speed (we recommend not exceeding 10 km/h), press the ON/OFF switch to confirm the reading. A 'Jingle' will confirm the speed reading has been learned by the buzzer.

### 10.3 - CHECK AFTER INSTALLATION

1. Reconnect the negative battery terminal.
2. Turn ignition key ON. Activation will be confirmed by a short Beep and the LED on the manual switch will turn ON.
3. Test the sensors one by one for detection by moving different obstacle simulators in front of the vehicle. The system should beep according to the warning zones.
  - Distances and detections are approximate because of the position, size and shape of the objects. For a more accurate detection, test the sensors by placing the objects at different angles of the sensors field of view.
  - If needed, the sensor sensitivity can be modified (see configuration table).
4. If the parking sensors are working correctly, secure the bumper in place.

## 11.0 - PARAMETER SET-UP



- Before configuring the system, ensure all connections have been done properly.
- Parameters must only be configured by qualified personnel.

System configuration with the parameters detailed in par.12.0 is done by pressing buttons "A" and "B" on the buzzer (see figure below).

- Press button "A" to select the parameter to configure.
- Press button "B" to select the desired setting.

### 11.1 - HOW TO ENTER IN PROGRAMMING MODE:

1. Turn ignition "ON".
2. Simultaneously press buttons "A" and "B" for approx 4 sec.
3. Operation will be confirmed by 1 Beep and 1 Red/Green LED flash.
4. Wait until the LED turns OFF.

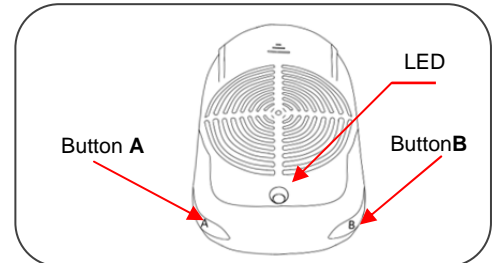

### 11.2 - PARAMETER SETUP:

1. Within 10 sec. after the LED turns OFF, press button "A" the number of times corresponding to the parameter to customize. At each button press there will be 1 Beep and 1 Red LED blink.
2. Press button "B" the number of times corresponding to the desired setup. At each button press there will be 1 Beep and 1 Green LED blink.  
**Example:** To set the maximum detection distance of the inner sensors at 80 cm => press button "A" twice and then button "B" 9 times.

### 11.3 - SETUP CONFIRMATION:

1. The buzzer will repeat the number of Beeps and blinks corresponding to the selected setup. After a few seconds, if the code has been successfully programmed, the buzzer will give off a 'Jingle'. Proceed with another setup.
2. In case of an incorrect entry, a low tone signal (Bop) will sound. Re-enter the desired code.

Turn ignition OFF and then back ON to transfer the new parameters from the buzzer to the control unit. The LED on the ON/OFF switch will blink during data transfer (data transfer timeout: 20 sec. max). A 'Jingle' will confirm data has been successfully transferred otherwise a Bop will sound. In this case, turn ignition OFF and then back ON to repeat data transfer. The next time ignition will be turned ON, the system will operate according to the configured parameters.

### 11.4 - RESTORE FACTORY SETTINGS

1. Simultaneously press and hold buttons "A" and "B"; turn ignition ON.
2. When the buzzer gives off a Beep, release buttons "A" and "B".
3. The LED will start blinking Red/Green.
4. When the LED stops blinking, a 'Jingle' will confirm the buzzer has been reset to the original factory settings.
5. Turn ignition OFF and then back ON to transfer parameters from the buzzer to the control unit. The LED on the ON/OFF switch will blink during data transfer (data transfer timeout: 20 sec. max). A Beep will confirm data has been successfully transferred otherwise a Bop will sound. In this case, turn ignition OFF and then back ON to repeat data transfer.

## 12.0 - PARAMETER CONFIGURATION TABLE

Programming can be done using the 2 buttons on the buzzer or via a user-friendly PC software.					
Programmable parameters	Button A	Button B	Settings		Default settings
			Buttons & PC	Only PC*	
Sensitivity	1	1	Low		Medium
		2	Medium		
		3	High		
Buzzer volume	1	7	Low		High
		8	High		
STOP zone => Inner Sensors	2	1	30 cm	35 cm	50 cm
		2	40 cm	45 cm	
		3	50 cm		
MAXIMUM distance => Inner Sensors	2	6	50 cm	55 cm	80 cm
		7	60 cm	65 cm	
		8	70 cm		
		9	80 cm		
STOP zone => Outer Sensors	3	1	30 cm	35 cm	40 cm
		2	40 cm	45 cm	
		3	50 cm		
MAXIMUM distance => Outer Sensors	3	5	50 cm	55 cm	70 cm
		6	60 cm	65 cm	
		7	70 cm		
		8	80 cm		
Deactivation delay (Maneuvering time period expired)	5	1	Never		30 sec.
		2	30 sec.		
		3	60 sec.		
ON/OFF via odometer	5	8	Automatic		Automatic
		9	OFF 1 time		
Odometer Number of speed signal pulses/m	6	1	3 pulses/m		9 pulses/m
		2	6 pulses/m		
		3	9 pulses/m		
		4	15 pulses/m		
		5	21 pulses/m		
		6	30 pulses/m		
Automatic speed reading	9	8			

\* A user friendly PC software allows more flexibility in programming the parameters. The dedicated interface also allows reading and overwriting previously configured parameters. Please contact us for more information.

## 13.0 - SENSOR FITTING AND OBSTACLE DETECTION

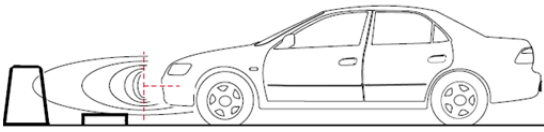

Correct Position: height, inclination and orientation are correct.\*

✓

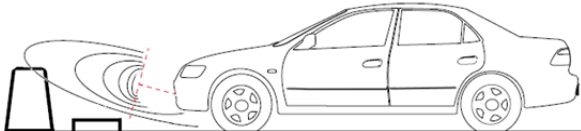

Sensors are excessively turned upwards  
=> low obstacles are not detected.

X

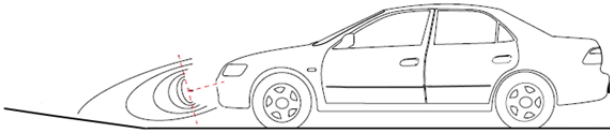

Sensors are excessively turned downwards => false alarms due to ground detection.

X

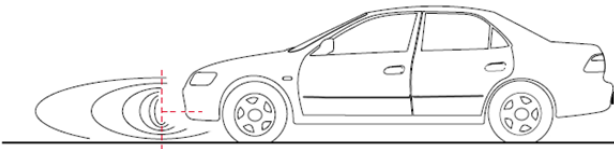

Sensors fitted too low => false alarms due to ground detection.

X

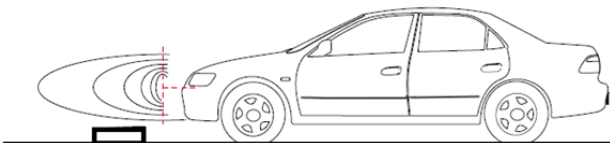

Sensors fitted too high => low obstacles are not detected.

X

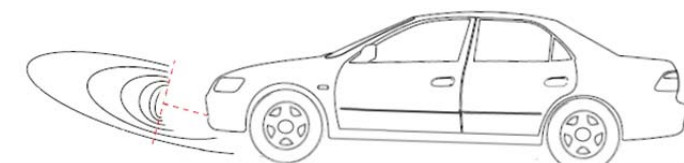

Sensors have been properly fitted but the vehicle weight has changed => the performance of the parking system is affected by the added weight.

!

\* Presence of human beings, animals or small obstacles or objects/materials with low reflectance might not be detected by the parking system.



## 14.0 - TROUBLESHOOTING

FAULTS	CAUSA / RISOLUZIONE
The system does not work when ignition is turned ON.	Check all connections.
A sound signal goes off when there is no obstacle in front of the vehicle.	Check that the arrow and the UP indication are pointing upwards.
	Ensure that the sensors have been installed at the correct height.
	If they read the ground, use the correction adapters to tilt the sensors upwards.
	Modify setting.
	Sensitivity might be too high. Adjust sensitivity.
	Check that there is no excessive paint on the sensor surface. Too much spray paint can impair sensor ability to function properly.
No warning signals.	Check connections.
False warning signals.	Back part of sensors in contact with frame. Create a separation between the sensors and the vehicle chassis (at least 2mm).

## 15.0 - WASTE ELECTRICAL AND ELECTRONIC EQUIPMENT (WEEE) DIRECTIVE

The present device does not fall within the scope of Directive 2002/96/EC on Waste Electrical and Electronic Equipment (WEEE) as specified in art. 2.1 of L. D. No. 151 of 25/07/2005.

## 16.0 - TECHNICAL SPECIFICATIONS

Power supply	12 - 24 Vdc
Current consumption – system ON	25mA @12V
Operating temperature range	-40°C / +85°C
Ultrasonic frequency	58 kHz